

Does Your Home Comply



Consumer products and cosmetics





**General prohibition of
unreasonably hazardous
products**

**“DANGER TO HUMAN
HEALTH OR SAFETY”**

BANNED PRODUCTS IN CANADA

In Canada it is illegal to manufacture, import, advertise or sell certain products such as:

- * Baby walkers

- * Lawn darts with elongated tips

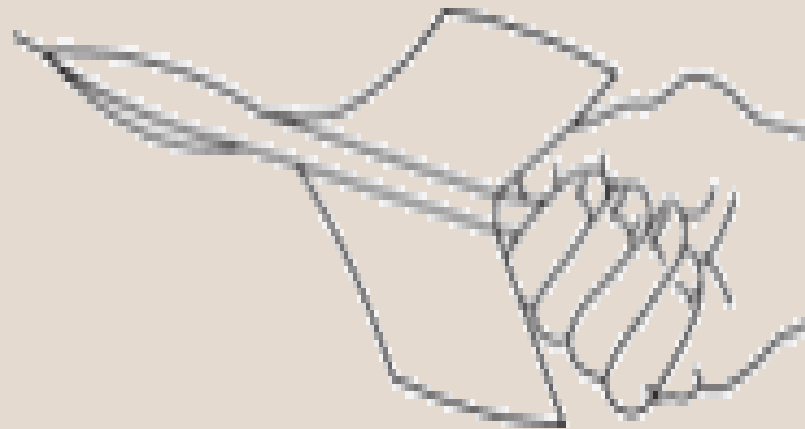
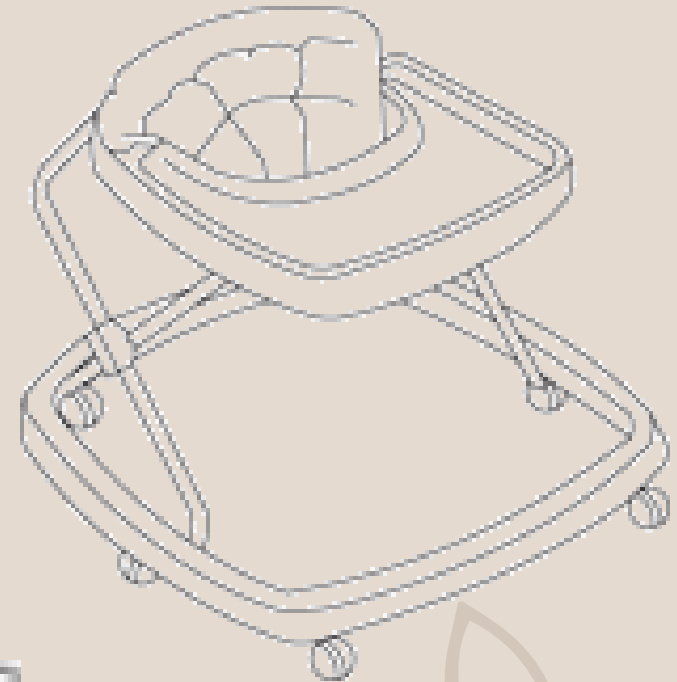

WHAT TO DO BEFORE SELLING A SECOND-HAND PRODUCT



[https://recalls-
rappels.canada.ca/en](https://recalls-rappels.canada.ca/en)

BASSINETS



Bassinets are products whose main function is to provide a sleeping space for a child, that includes sides to confine the child and that has a sleeping surface area that is less than or equal to 4 000 cm² (620 in²).

- The Cribs, Cradles and Bassinets Regulations set out several requirements for bassinets. The following discusses some, but not all, of these requirements. You should therefore consult the Regulations to ensure that all the applicable requirements are met. The following information must be permanently affixed to the bassinet, in English and French:

- name and place of business in Canada of manufacturer or importer
 - model name or number
 - date of manufacture
 - warning statements about following assembly instructions, the size of the mattress, proper use of product and other statements specified in the Cribs, Cradles and Bassinets Regulations
- The assembly instructions and parts list, in English and French, must be either permanently printed on the product or included in a pouch that is permanently attached to the bassinet. As well as.....

Car seats and booster seats

The Restraint Systems and Booster Seats for Motor Vehicles Regulations set out, for the purposes of the CCPSA, several requirements for car seats and booster seats. These Regulations in turn reference Transport Canada's Motor Vehicle Restraint Systems and Booster Seats Safety Regulations. The following discusses some, but not all, of these requirements. You should therefore consult the above-noted regulations to ensure that all the applicable requirements are met.

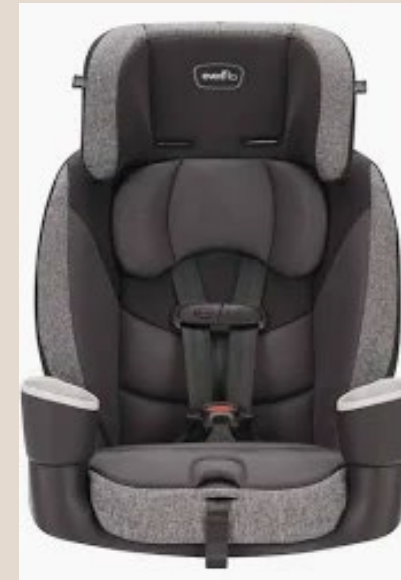

- A company may apply the National Safety Mark on a car seat or booster seat on condition that the product conforms to all the applicable Canada Motor Vehicle Safety Standards.
- The product must have stitched onto it, indelibly moulded into or onto it, or indelibly printed on a label affixed to it in a permanent manner, the following, in English and French:.....

Car Seats Booster seats Con't

1. name and address of manufacturer, importer or retailer
2. model name and number
3. date of manufacture
4. statements for weight and height range of user
5. characteristics of vehicles in which the product is not to be used
6. warning statements
7. installation diagrams

- The instructions, in English and French, for proper installation and use must be available at the time of sale.
- All forward-facing car seats must have a tether strap.
- All car seats must have a functional restraint system (harness system).
- The product should be in good condition. For example, there should be no cracks in the plastic, missing hardware or loose parts.
- Never sell a car seat or booster seat if it has been in a vehicle at the time of a collision.

Please be aware that most, if not all, manufacturers place an expiry date on their child car seats and booster seats, even though it is not regulated or required by Transport Canada. For questions regarding the expiry date for a specific child car seat or booster seat, please contact the manufacturer

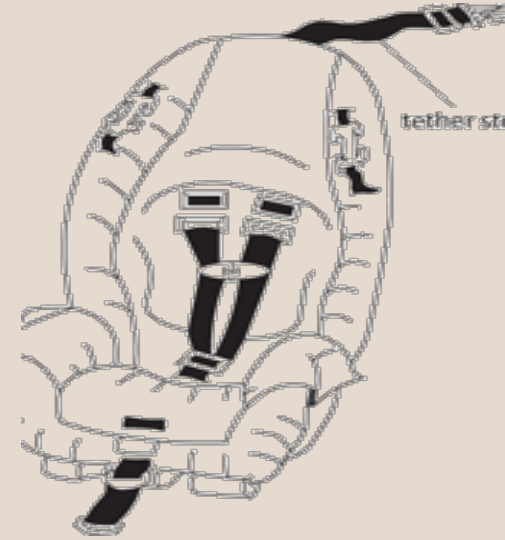

For complete information about the requirements for restraint systems and booster seats consult the Restraint Systems and Booster Seats for Motor Vehicles Regulations.

For further information on car seats, including recalls, contact Transport Canada at 1-800-333-0371 or visit their [Web site](https://tc.canada.ca/en/road-transportation).
<https://tc.canada.ca/en/road-transportation>

Carriages and strollers

The Carriages and Strollers Regulations set out several requirements for carriages and strollers. The following discusses some, but not all, of these requirements. You should therefore consult the Regulations to ensure that all the applicable requirements are met.

- A label containing the following information must be permanently affixed to the product:
 - name and place of business of manufacturer or importer
 - model name or number
 - date of manufacture
 - warning statements, in English and French, about never leaving a child unattended, using the lap belt and using the parcel bag only as recommended by the manufacturer
- The product must have instructions, in English and French, which are on the product or with the product.
- The product must have a braking device in working order.
- The wheels should be securely attached.
- Every stroller must have a working 3-point harness (i.e., waist and crotch belt) to prevent the child from sliding downward.
- Products that fold must have a latching device which locks automatically and prevents the product from folding by itself.
- The product should be in good condition and have no loose parts which pose a choking hazard to a child.
- For more complete information about the requirements for carriages and strollers consult the Carriages and Strollers Regulations.

Children's jewellery



- THE CHILDREN'S JEWELLERY REGULATIONS SET OUT SEVERAL REQUIREMENTS FOR CHILDREN'S JEWELLERY. THE FOLLOWING DISCUSSES SOME, BUT NOT ALL, OF THESE REQUIREMENTS. YOU SHOULD THEREFORE CONSULT THE REGULATIONS TO ENSURE THAT ALL THE APPLICABLE REQUIREMENTS ARE MET.
- LEAD IS A SOFT, HEAVY METAL WHICH IS OFTEN USED TO MAKE INEXPENSIVE JEWELLERY. LEAD TASTES SWEET AND A CHILD CAN SUFFER FROM LEAD POISONING IF THEY SUCK, CHEW, OR SWALLOW JEWELLERY CONTAINING LEAD. LEAD IS VERY TOXIC. CADMIUM IS ALSO A TOXIC HEAVY METAL. CHILDREN'S JEWELLERY ITEMS CONTAINING HIGH LEAD OR CADMIUM LEVELS HAVE BEEN FOUND ON THE CANADIAN MARKET.

- Jewellery containing lead or cadmium which has a protective or decorative coating is not safe, since children can easily chew off the coating.
- Jewellery for children under 15 years of age must not contain more than 90 mg/kg of total lead.
- Jewellery for children under 15 years of age must not contain more than 130 mg/kg of total cadmium.
- If you are not sure if a children's jewellery product contains lead or cadmium above the regulated limits, you should not import, advertise or offer it for sale.

For complete information about the requirements for children's jewellery consult the [Children's Jewellery Regulations](https://laws-lois.justice.gc.ca/eng/regulations/SOR-2018-82/index.html). <https://laws-lois.justice.gc.ca/eng/regulations/SOR-2018-82/index.html>

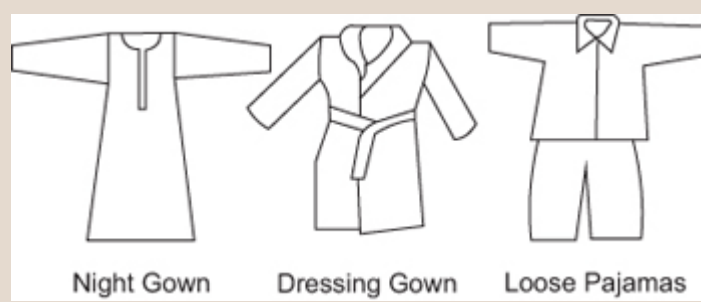

Children's sleepwear

- The Children's Sleepwear Regulations set out several requirements for children's sleepwear. The following discusses some, but not all, of these requirements. You should therefore consult the Regulations to ensure that all the applicable requirements are met.
- The requirements for children's sleepwear apply to those products up to a children's size 14X. Children's sleepwear must comply with the Regulations which include specific requirements concerning flammability.

- **Loose-fitting** children's sleepwear includes night gowns, nightshirts, dressing gowns, bathrobes, house coats, robes, pyjamas, and baby doll pyjamas. Loose-fitting sleepwear made of 100% polyester, 100% nylon or polyester/nylon blends are more difficult to ignite and are more likely to comply, whereas loose-fitting children's sleepwear made from cotton, cotton blends or rayon ignite readily and burn rapidly and likely do not meet the flammability requirements.

Only testing can ensure that a fabric complies with the Regulations.

- Check the label to see what materials the product is made from to be sure. If there is no label, it may be better not to sell the product. **Tight-fitting** children's sleepwear includes polo pyjamas and sleepers with tight cuffs at the end of sleeves and pants and fit close to the body. These styles are less likely to make contact with a fire source, are likely to burn more slowly and can be made from cotton or cotton blends.
- Health Canada recommends that belts, ties or sashes on children's robes be stitched firmly to the centre back of these products. Young children are at risk of strangulation from any type of cord that can be detached from the clothing.

For complete information about the requirements for children's sleepwear consult the Children's Sleepwear Regulations.

Corded window coverings

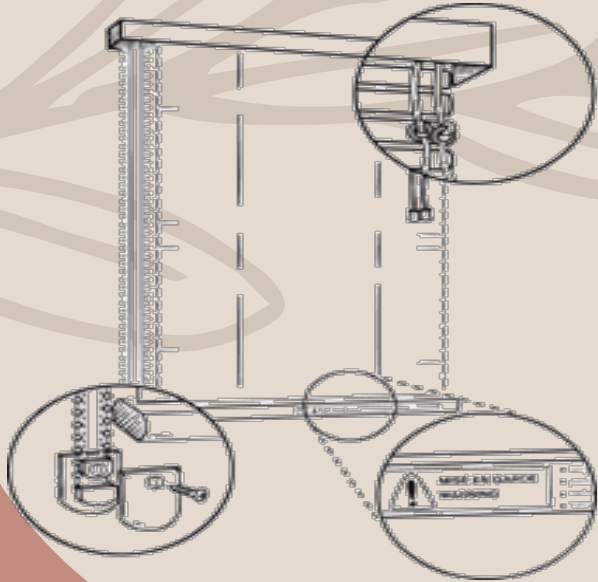

THE CORDED WINDOW COVERING PRODUCTS REGULATIONS SET OUT SEVERAL REQUIREMENTS FOR CORDED WINDOW COVERINGS. THE FOLLOWING DISCUSSES SOME, BUT NOT ALL, OF THESE REQUIREMENTS. YOU SHOULD THEREFORE CONSULT THE REGULATIONS TO ENSURE THAT ALL THE APPLICABLE REQUIREMENTS ARE MET.

CHILDREN CAN STRANGLE ON CORDS AND BEAD CHAINS OF BLINDS AND CURTAINS. A LOOPED CORD CAN ACT AS A NOOSE AND LONG PULL CORDS CAN WRAP AROUND A CHILD'S NECK.

BLINDS OR CURTAINS WITH PULL CORDS SHOULD NOT BE SOLD UNLESS THEY HAVE TENSION DEVICES ATTACHED TO ANY LOOPED PULL CORD:

- DEVICES ON THE PULL CORDS TO STOP THE INNER CORDS FROM BEING PULLED OUT; AND
- LABELS WITH INSTRUCTIONS IN ENGLISH AND FRENCH TO KEEP PULL CORDS OUT OF THE REACH OF CHILDREN.

FOR COMPLETE INFORMATION ABOUT THE REQUIREMENTS FOR CORDED WINDOW COVERINGS CONSULT THE CORDED WINDOW COVERINGS PRODUCTS REGULATIONS.

Cosmetics



IT IS NOT RECOMMENDED TO SELL USED, OLD, OR DAMAGED COSMETICS AS THEY MAY CONTAIN HARMFUL BACTERIA THAT COULD CAUSE SKIN RASHES OR LEAD TO INFECTIONS. ADDITIONALLY, SECOND-HAND COSMETICS MAY BE MISSING REQUIRED LABELLING INFORMATION, SUCH AS INGREDIENTS, WARNINGS AND DIRECTIONS FOR SAFE USE.

FOR COMPLETE INFORMATION ABOUT THE REQUIREMENTS FOR COSMETICS CONSULT THE COSMETIC REGULATIONS.

Cradles

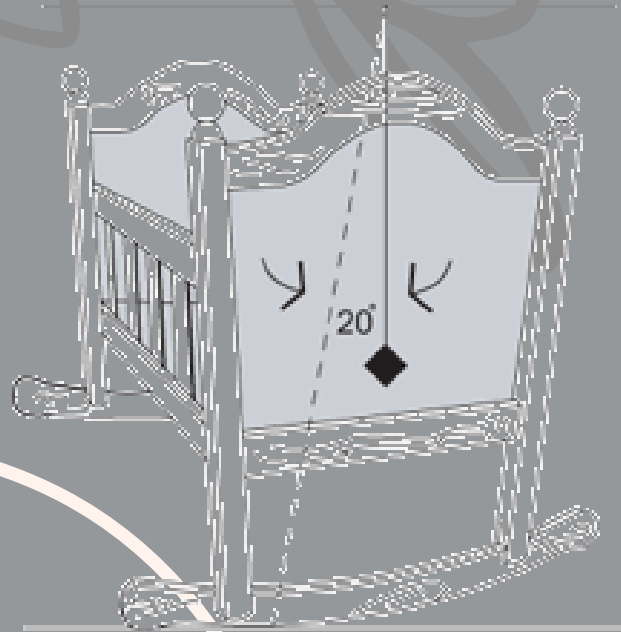

CRADLES ARE PRODUCTS WHOSE MAIN FUNCTION IS TO PROVIDE A SLEEPING SPACE FOR A CHILD AND THAT HAS A SLEEPING SURFACE AREA THAT IS GREATER THAN 4 000 CM² (620 IN²), BUT LESS THAN 10 000 CM² (1550 IN²). CRADLES AND BASSINETS REGULATIONS SET OUT SEVERAL REQUIREMENTS FOR CRADLES. THE FOLLOWING ARE THE MAIN REQUIREMENTS. YOU SHOULD THEREFORE CONSULT THE REGULATIONS TO ENSURE THAT YOUR CRADLE MEETS ALL THE

THE FOLLOWING INFORMATION MUST BE PERMANENTLY ATTACHED TO THE CRADLE:

- name and place of the manufacturer
- warning statements about following assembly instructions, the size of the mattress, proper use and cleaning instructions
- THE ASSEMBLY INSTRUCTIONS AND PARTS LIST, IN ENGLISH AND FRENCH, MUST BE EITHER PRINTED ON THE CRADLE OR INCLUDED IN A POUCH
- CRADLES MUST HAVE AT LEAST A SIDE HEIGHT OF 230 MM (9 IN) AS MEASURED FROM THE TOP OF THE MATTRESS TO THE TOP OF THE CRADLE
- THE CRADLE MUST NOT ROCK OR SWING BEYOND A 20° ANGLE FROM THE VERTICAL
- THE GAP BETWEEN THE MATTRESS AND THE CRADLE MUST NOT BE GREATER THAN 5 MM
- THE MATTRESS SUPPLIED WITH THE CRADLE SHOULD BE IN GOOD CONDITION AND MUST BE OF A SIZE THAT, WHEN PUSHED FIRMLY AGAINST ANY SIDE OF THE CRADLE DOES NOT LEAVE A GAP
- THE CRADLE SHOULD BE IN GOOD CONDITION, FOR EXAMPLE, WITH NO BROKEN, CRACKED OR EXPOSED WOOD, PLASTIC OR SIMILAR MATERIAL MUST BE SMOOTH AND FREE OF SPLITS, CRACKS AND BURRS. ALL SURFACES MUST BE SMOOTH AND FREE OF S

Cribs

CRIBS ARE PRODUCTS WHOSE MAIN FUNCTION IS TO PROVIDE A SLEEPING SPACE FOR A CHILD, THAT INCLUDES SIDES

IT IS ILLEGAL TO ADVERTISE, IMPORT, SELL OR GIVE AWAY CRIBS THAT DO NOT MEET THE CURRENT REGULATORY RE
NOT MEET THESE REQUIREMENTS AND SHOULD THEREFORE NOT BE USED. INFANTS HAVE BEEN SERIOUSLY INJURED
CRIBS OLDER THAN TEN YEARS ARE MORE LIKELY TO HAVE BROKEN, WORN, L

THE CRIBS, CRADLES AND BASSINETS REGULATIONS SET OUT SEVERAL REQUIREMENTS FOR CRIBS. THE FOLLOWING
THEREFORE CONSULT THE REGULATIONS TO ENSURE THAT ALL THE APPLICABLE REQUIREMENTS ARE M

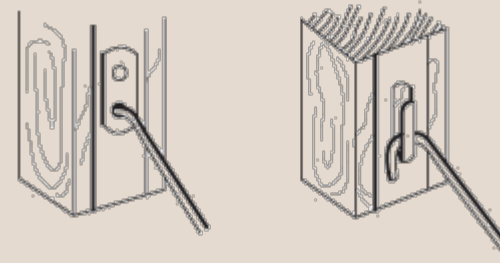

- THE FOLLOWING INFORMATION

- warning statements about following assembly instructions, the size of the mattress, proper use o

- THE ASSEMBLY INSTRUCTIONS AND PARTS LIST, IN ENGLISH AND FRENCH, MUST BE EITHER P

- CRIBS MUST HAVE A SIDE HEIGHT OF AT LEAST 230 MM (9 IN) AS MEASURED FROM THE TO
THE TOP OF THE LOWEST PART OF THE SIDE; AND A SIDE HEIGHT OF AT LEAST 660 MM (26 I
IN THE LOWE

- THE MATTRESS SUPPORT SYSTEM MUST BE SOLIDLY AFFIXED TO THE FRAME OF THE CR
ADJUSTABLE WITHOUT T

- THE GAP BETWEEN THE SLATS MUST NOT BE MORE THAN 6 CM (2 3/8 IN) AND THE SLATS I

- THE MATTRESS SUPPLIED WITH THE CRIB SHOULD BE IN GOOD CONDITION AND MUST I
WHEN PUSHED FIRMLY AGAINST ANY SIDE OF THE CRIB DOES NOT LEAVE A GAP OF MORE TH

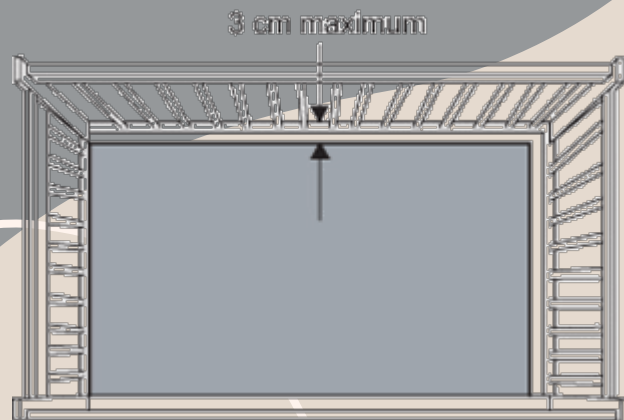

THE CRIB SHOULD NOT HAVE CORNER POSTS WHICH EXTEND MORE THAN 3 MM (1/8 IN) ABOVE
THAT EXTEND MORE THAN 406 MM (16 IN) ABOVE THE HIGHEST SIDE PRO

Playpens/ pack and play

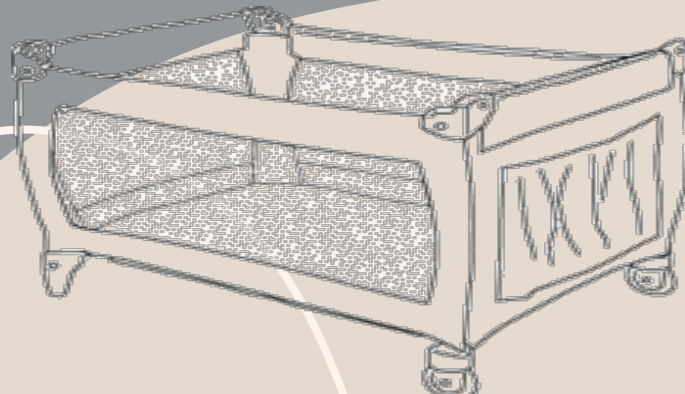

THE PLAYPENS REGULATIONS SET OUT SEVERAL REQUIREMENTS FOR PLAYPENS. THE FOLLOWING DISCUSSES SOME, BUT NOT ALL, OF THESE REQUIREMENTS. YOU SHOULD THEREFORE CONSULT THE REGULATIONS TO ENSURE THAT ALL THE APPLICABLE REQUIREMENTS ARE MET.

- THE FOLLOWING INFORMATION MUST BE INDELIBLY PRINTED ON THE PLAYPEN OR OTHERWISE PERMANENTLY AFFIXED TO IT, IN ENGLISH AND FRENCH:
 - name and place of business of manufacturer or importer
 - model name or number
 - date of manufacture
 - the following statement:
"This product complies with requirements of the Playpens Regulations (Canada) / Ce produit est conforme aux exigences du Règlement sur les parcs pour enfants (Canada)"
- ENGLISH AND FRENCH ASSEMBLY INSTRUCTIONS MUST ACCOMPANY THE PRODUCT.
- THE PLAYPEN MUST NOT PRESENT ANY SCISSORING, SHEARING OR PINCHING HAZARDS. THE JOINT AT THE TOP DROP RAIL MUST BE COVERED BY A PLASTIC PAD OR DESIGNED TO ELIMINATE SHEARING OR PINCHING HAZARDS.
 - THE HEIGHT OF THE SIDES, AS MEASURED FROM THE FLOOR TO THE TOP OF THE RAIL, MUST BE 48 CM (18.9 IN) OR MORE.
- THE PRODUCT MUST NOT HAVE MORE THAN TWO WHEELS OR CASTERS OR THE ABILITY TO ATTACH ADDITIONAL WHEELS OR CASTERS.
- PLAYPEN MESH MUST BE SMALL, SIMILAR TO MOSQUITO-TYPE NETTING, TO PREVENT BUTTONS LOCATED NEAR THE HEAD AND NECK ON CHILDREN'S CLOTHING FROM CATCHING AND LEADING TO STRANGULATION.
 - CUT METAL TUBING WITH ENDS ACCESSIBLE TO THE CHILD MUST BE COVERED BY A CAP THAT CANNOT BE REMOVED.
 - THE THREADED END OF BOLTS ACCESSIBLE TO THE CHILD MUST BE COVERED WITH ACORN NUTS OR OTHER SUITABLE DEVICE.
- STRAPS, CORDS, ETC. MORE THAN 18 CM (7 IN) IN LENGTH CANNOT BE ATTACHED TO THE PLAYPEN AS THEY CREATE A STRANGULATION HAZARD.
 - THE PLAYPEN SHOULD BE IN GOOD CONDITION.
- IT IS RECOMMENDED THAT PLAYPEN ACCESSORIES MEET THE MOST CURRENT REQUIREMENTS FOUND IN THE AMERICAN SOCIETY FOR TESTING AND MATERIALS (ASTM) STANDARD, ASTM F406 - STANDARD CONSUMER SAFETY SPECIFICATION FOR NON-FULL-SIZE BABY CRIBS AND PLAY YARDS.

FOR COMPLETE INFORMATION ABOUT THE REQUIREMENTS FOR PLAYPENS CONSULT THE PLAYPENS REGULATIONS.



THE HAZARDOUS PRODUCTS (EXPANSION GATES AND EXPANDABLE ENCLOSURES) REGULATIONS SET OUT SEVERAL REQUIREMENTS FOR SAFETY GATES AND ENCLOSURES. THE FOLLOWING DISCUSSES SOME, BUT NOT ALL, OF THESE REQUIREMENTS. YOU SHOULD THEREFORE CONSULT THE REGULATIONS TO ENSURE THAT ALL THE APPLICABLE REQUIREMENTS ARE MET.

Safety gates and enclosures

- THE FOLLOWING INFORMATION MUST BE INDELIBLY PRINTED ON OR PERMANENTLY AFFIXED TO THE GATE:
 - name and place of business in Canada of the manufacturer, importer or distributor
 - model name or number
 - date of manufacture
 - warning statements, in English and French, about the intended use, age limits and installation as specified in the Regulations
- ENGLISH AND FRENCH ASSEMBLY AND INSTALLATION INSTRUCTIONS MUST ACCOMPANY THE PRODUCT.
- ANY V SHAPED OPENINGS ALONG THE UPPER EDGE OF THE GATE MUST HAVE A SPACING OF 38 MM (1 1/2 IN) OR LESS WHEN INSTALLED AS RECOMMENDED BY THE MANUFACTURER.

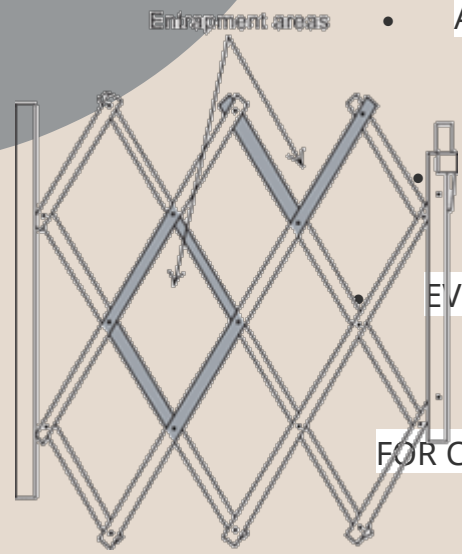

OPENINGS IN A GATE MUST BE SMALL ENOUGH TO PREVENT A CHILD FROM PLACING THEIR HEAD THROUGH THE HOLES.

EVERY EXPOSED WOODEN, METAL OR PLASTIC PART MUST BE SMOOTHLY FINISHED AND FREE OF SPLINTERS, BURRS, CRACKS AND OTHER DEFECTS.

FOR COMPLETE INFORMATION ABOUT THE REQUIREMENTS FOR EXPANSION GATES AND EXPANDABLE ENCLOSURES CONSULT THE HAZARDOUS PRODUCTS (EXPANSION GATES AND EXPANDABLE ENCLOSURES) REGULATIONS

Toy boxes and Toys



- TOY BOXES WITH LIDS ARE REQUIRED TO HAVE ADEQUATE OPENING FOR VENTILATION IN EACH OF TWO OR MORE ADJACENT SIDES TO PREVENT THE SUFFOCATION OF A CHILD WHO MAY BECOME TRAPPED INSIDE. IF THERE IS A LID ON THE TOY BOX, IT SHOULD BE LIGHTWEIGHT AND HAVE GOOD SUPPORTING HINGES

- PLASTIC, RUBBER OR SIMILAR AIR-TIGHT STORAGE BINS THAT ARE LARGE ENOUGH TO ENCLOSE A CHILD CANNOT BE PROMOTED FOR TOY STORAGE

FOR COMPLETE INFORMATION ABOUT THE REQUIREMENTS FOR TOYS CONSULT THE TOYS REGULATIONS

THE TOYS REGULATIONS SET OUT SEVERAL REQUIREMENTS FOR TOYS THE FOLLOWING DISCUSSES SOME, BUT NOT ALL, OF THESE REQUIREMENTS. YOU SHOULD THEREFORE CONSULT THE REGULATIONS TO ENSURE THAT ALL THE APPLICABLE REQUIREMENTS ARE MET

TOYS FOR CHILDREN UNDER THREE YEARS OF AGE MUST NOT HAVE SMALL PARTS THAT POSE A CHOKING HAZARD. SEE THE REGULATIONS FOR THE SPECIFIC REQUIREMENTS

- ENSURE THAT TOYS ARE IN GOOD REPAIR. FOR EXAMPLE, THERE MUST BE NO SHARP EDGES OR POINTS, NO LOOSE EYES OR NOSES AND NO ROUGH WOODEN EDGES. ALL FASTENERS SUCH AS NAILS, STAPLES, BOLTS AND SCREWS MUST BE SECURELY ATTACHED

TOYS SHOULD NOT HAVE ANY PAINT PEELING FROM THE PRODUCT

Toys sold in flexible film bags / Toys that emit sound/ Toys With Magnets



- Toys packaged in flexible film bags that have an opening of 35.6 cm (14 in) in circumference or larger, must be labelled with an English and French suffocation warning.

"PLASTIC BAGS CAN BE DANGEROUS. TO AVOID DANGER OF SUFFOCATION, KEEP THIS BAG AWAY FROM BABIES AND CHILDREN.

LES SACS DE PLASTIQUE PEUVENT ÊTRE DANGEREUX. POUR ÉVITER LE DANGER DE SUFFOCATION, NE LAISSEZ PAS CE SAC À LA PORTÉE DES BÉBÉS NI DES ENFANTS."

In addition, the bag must be made from film that is at least 0.019 mm thick, so thin bags such as drying cleaning bags cannot be used.

Toys that emit sound

- Toys that are excessively loud - that is, that exceed 100 dB when measured at a distance that the toy would ordinarily be from the ear of the child who is using it - cannot be sold in Canada. If you have to yell to be heard above the sound of a toy, then it is likely too loud for a child and should not be sold.
- **Toys with magnets**

Magnetic attraction is a popular play feature in children's toys. Certain magnets, such as those that are small and powerful can pose a serious ingestion hazard to children of all ages. If small powerful magnets are swallowed, they can attract across several layers of intestines and cause serious injuries or death.

In 2018, the Toys Regulations were amended to set out several requirements to protect children from this hazard with magnetic toys. The requirements restrict both the size and the attractive strength of magnetic toys and magnetic components of toys. The restrictions apply to toys intended for children of any age, and they include a series of integrity tests to verify that dangerous magnetic components do not separate from a toy or its components when used. Be aware that small powerful magnets may be found in a wide range of toys including: construction sets, puzzles, action figures and dolls, science kits and board games.

Ice hockey helmets and face protectors

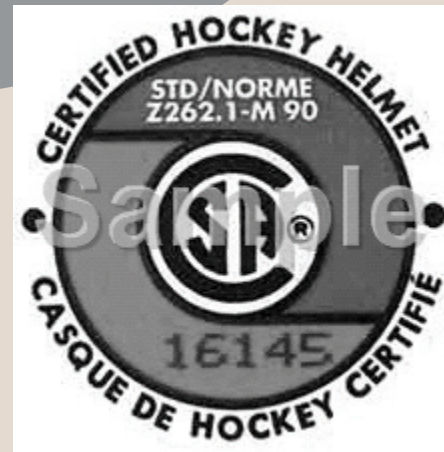

THE [ICE HOCKEY HELMET REGULATIONS](#) AND [FACE PROTECTORS FOR ICE HOCKEY AND BOX LACROSSE PLAYERS REGULATIONS](#) SET OUT

SEVERAL REQUIREMENTS FOR ICE HOCKEY HELMETS AND FOR FACE PROTECTORS FOR HOCKEY AND LACROSSE, RESPECTIVELY. THE FOLLOWING DISCUSSES SOME, BUT NOT ALL, OF THESE REQUIREMENTS. YOU SHOULD THEREFORE CONSULT THE [REGULATIONS](#) TO ENSURE THAT ALL THE APPLICABLE REQUIREMENTS ARE MET.

ICE HOCKEY HELMETS MUST MEET THE PERFORMANCE AND LABELLING REQUIREMENTS OF THE CANADIAN STANDARDS ASSOCIATION (CSA) STANDARD Z262.1.

- THE NUMBER OF THE CSA STANDARD CSA Z262.1 MUST APPEAR ON THE ICE HOCKEY HELMET.
- ICE HOCKEY HELMETS MUST ALSO DISPLAY THE DATE OF MANUFACTURE. HELMETS MORE THAN FIVE YEARS OLD SHOULD NOT BE BOUGHT OR SOLD AS THE MATERIALS USED IN THE HELMET MAY BREAK DOWN WITH AGE.
- THE PRODUCT SHOULD BE IN GOOD CONDITION, WITH NO CRACKS, MISSING PADDING OR HARDWARE. MODIFICATIONS, SUCH AS DRILLED HOLES, STICKERS OR RE-PAINTING SHOULD NOT HAVE BEEN DONE.
- ICE HOCKEY HELMETS MUST HAVE A FUNCTIONING CHIN STRAP.

FACE PROTECTORS FOR ICE HOCKEY MUST MEET CSA STANDARD CAN 3-Z262.2-M78, BUT IT IS RECOMMENDED THAT THESE PRODUCTS MEET THE REQUIREMENTS OF THE MOST CURRENT CSA-Z262.2 STANDARD FOR FACE PROTECTORS FOR USE IN ICE HOCKEY.

- THE NUMBER OF THE CSA STANDARD CSA Z262.2 MUST APPEAR ON THE FACE PROTECTORS FOR ICE HOCKEY HELMETS.
- FOR GOALTENDER ICE HOCKEY HELMETS, WHERE THE ICE HOCKEY FACE PROTECTOR IS INTEGRALLY MOUNTED ON THE HELMET, THE FACE PROTECTOR ITSELF WOULD NOT REQUIRE THE CSA NUMBER. THE ICE HOCKEY HELMET MUST HAVE BOTH THE CSA STANDARD NUMBER CSA Z262.2 (FOR THE FACE PROTECTOR), AND CSA Z262.1 (FOR THE HELMET).
- THE FACE PROTECTOR SHOULD BE IN GOOD REPAIR WITH NO CRACKS OR BENT WIAPPROPRIATERES, AND FASTENED SECURELY TO THE HELMET. IF THE FACE PROTECTOR IS SOLD SEPARATELY, IT MUST HAVE THE HARDWARE FOR PROPER INSTALLATION AND INSTRUCTIONS ON HOW TO INSTALL.

CSA CERTIFICATION CAN BE AN INDICATION THAT THE HELMET OR FACE PROTECTOR MEETS THE [REGULATIONS](#). AN EXAMPLE OF HOW THE CERTIFICATION STICKER MAY APPEAR IS FOUND BELOW. IF IN DOUBT, CHECK THE LIST OF [CSA CERTIFIED PRODUCTS](#).

FOR COMPLETE INFORMATION ABOUT THE REQUIREMENTS FOR ICE HOCKEY HELMETS CONSULT THE [ICE HOCKEY HELMET REGULATIONS](#).

FOR COMPLETE INFORMATION ABOUT THE REQUIREMENTS FOR FACE PROTECTORS FOR ICE HOCKEY AND BOX LACROSSE CONSULT THE [FACE PROTECTORS FOR ICE HOCKEY AND BOX LACROSSE PLAYERS REGULATIONS](#).

THESE PRODUCTS ARE DESIGNED TO PROTECT AGAINST ONE MAJOR IMPACT. IT IS NOT RECOMMENDED TO RESELL THESE ITEMS.

BUNK BEDS

Products not subject to product-specific regulations

- THE TOP BUNK SHOULD HAVE GUARDRAILS ON ALL SIDES OF THE BED.
 - THE LADDER SHOULD BE IN GOOD CONDITION AND SECURELY ATTACHED TO THE BED.
 - CORNER POSTS OR TOPS OF THE LADDER UPRIGHTS SHOULD NOT EXTEND MORE THAN 5 MM (0.2 INCHES) HIGHER THAN THE ADJACENT SURFACE, SUCH AS GUARD RAILS OR END PANELS, TO PREVENT SNAGGING OF CLOTHES.
 - CHECK TO MAKE SURE THAT THE FRAME OF THE BED IS SOLID.
- CHECK THE WELDS ON METAL BUNK BEDS WHERE THE BED FRAME IS FIXED TO THE STRUCTURE. METAL BUNK BEDS WITH WELD CRACKS SHOULD NOT BE SOLD.
- THE MATTRESS SHOULD FIT SNUGLY ON ALL SIDES AND ITS SLEEPING SURFACE SHOULD BE AT LEAST 127 MM (5 IN) BELOW THE TOP OF THE GUARDRAILS AND END PANELS.

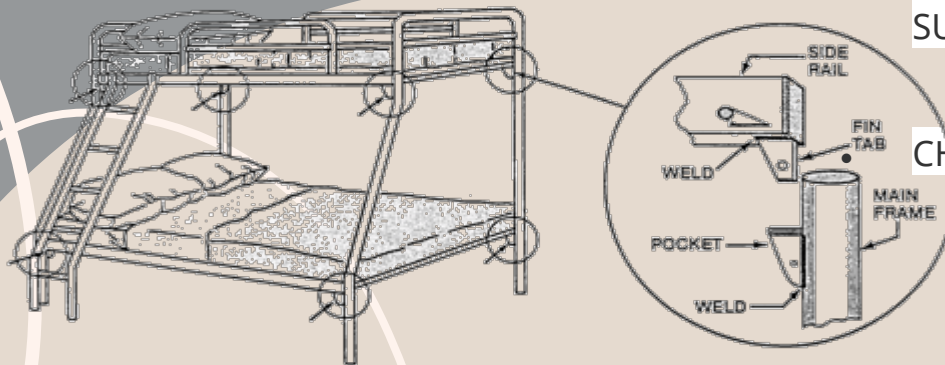

CHECK FOR A LABEL THAT INDICATES THAT THE BUNK BED MEETS THE REQUIREMENTS OF THE CURRENT AMERICAN SOCIETY FOR TESTING AND MATERIALS (ASTM) STANDARD, ASTM F1427 - STANDARD CONSUMER SAFETY SPECIFICATION FOR BUNK BEDS.

Products not subject to product-specific regulations

Continued

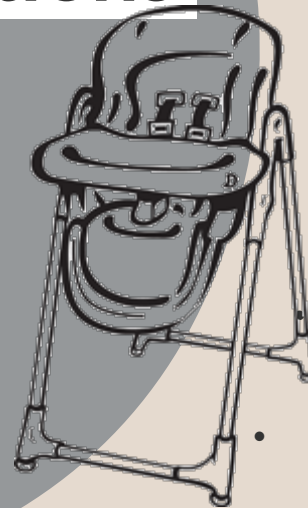
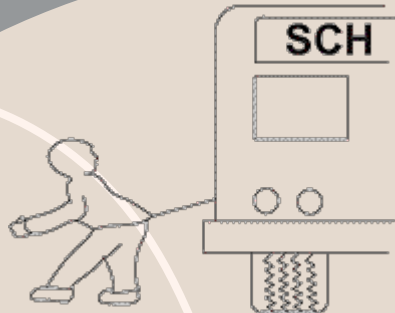
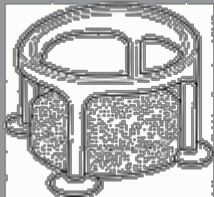
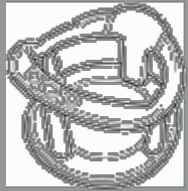

ALL DRAWSTRINGS SHOULD BE REMOVED FROM CHILDREN'S CLOTHING. DRAWSTRINGS OR CORDS ON CHILDREN'S SNOWSUITS, JACKETS AND SWEATSHIRTS CAN BECOME CAUGHT ON PLAYGROUND EQUIPMENT, FENCES OR OTHER OBJECTS AND RESULT IN STRANGULATION. IF A DRAWSTRING IS CAUGHT ON A VEHICLE, THE CHILD CAN BE DRAGGED.

HIGH CHAIRS

- IT IS RECOMMENDED THAT A LABEL CONTAINING THE FOLLOWING INFORMATION BE PERMANENTLY AFFIXED TO THE PRODUCT:
 - name and address of manufacturer
 - model name or number
 - date of manufacture

- A CHAIR SHOULD BE STABLE AND HAVE A WIDE BASE TO REDUCE THE RISK OF TIPPING.

THERE SHOULD BE A RESTRAINT SYSTEM THAT CONSISTS OF A STRAP WHICH FITS BETWEEN THE CHILD'S LEGS AND A WAIST BELT THAT IS EASY TO FASTEN. THE RESTRAINT SYSTEM SHOULD BE IN GOOD CONDITION.

- VERIFY THAT ALL LATCHING AND LOCKING MECHANISMS FOUND ON THE PRODUCT ARE IN GOOD WORKING ORDER.
- EXPOSED WOODEN OR PLASTIC PARTS SHOULD BE SMOOTHLY FINISHED AND FREE FROM SPLITS, CRACKS OR OTHER DEFECTS.
- PRODUCT SHOULD BE IN GOOD CONDITION AND HAVE NO LOOSE PARTS WHICH POSE A CHOKING HAZARD TO A CHILD. CHECK FOR A LABEL THAT INDICATES THAT THE HIGH CHAIR MEETS THE REQUIREMENTS OF THE CURRENT ASTM F404 - STANDARD CONSUMER SAFETY SPECIFICATION FOR HIGH CHAIRS.

LIST OF OTHER PRODUCTS ARE...



Information on product recalls

FOR SECOND-HAND RETAILERS, IT IS VERY IMPORTANT TO CHECK THAT THE CONSUMER PRODUCTS YOU RECEIVE HAVE NOT BEEN RECALLED, AS CHILDREN HAVE BEEN INJURED AND HAVE DIED USING RECALLED PRODUCTS. ALSO, WHEN RECALLED PRODUCTS HAVE BEEN REPAIRED WITH RETROFIT KITS, OR OTHER MEANS OFFERED BY THE MANUFACTURER, MAKE SURE THE PRODUCT HAS BEEN CORRECTED PROPERLY AS DIRECTED BY THE MANUFACTURER.

TO LEARN IF A CONSUMER PRODUCT HAS BEEN RECALLED IN CANADA, CHECK WITH THE FOLLOWING:

- PRODUCT MANUFACTURER, IMPORTER OR DISTRIBUTOR
 - [HEALTH CANADA](#)
 - [TRANSPORT CANADA](#)

RECALLS FROM THE UNITED STATES REGARDING CONSUMER PRODUCTS FROM THE [CONSUMER PRODUCT SAFETY COMMISSION](#) (CPSC) ARE AVAILABLE ON: WWW.CPSC.GOV/CPSCPUB/PREREL/PREREL.HTML

SUBSCRIBE TO CONSUMER PRODUCT SAFETY NEWS, THE CONSUMER PRODUCT SAFETY DIRECTORATE'S ELECTRONIC NEWSLETTER. SUBSCRIBERS RECEIVE UPDATES WHEN NEW INFORMATION, CONSUMER ADVISORIES AND WARNINGS, RECALLS AND CONSULTATION DOCUMENTS REGARDING CONSUMER PRODUCT SAFETY ARE POSTED ON THE

[HEALTH CANADA WEBSITE.](#)



DID YOU KNOW.....

THAT THERE IS A CHANCE THAT YOUR INSURANCE COMPANY HAS DIFFERENT RESTRICTIONS ON WHAT YOU CAN SELL AND WHAT YOU CAN'T SELL....

OUR INSURANCE COMPANY HAS ADVISED US THE FOLLOWING FROM THE UNDERWRITERS OF OUR POLICY THAT...

- Second Hand Goods Clause applies(Consumer Product Safety Program)
- No sales of medical equipment or children furniture (new or used).

YOUR AUXILIARY DIRECTORS SHOULD KNOW THIS INFORMATION EVEN IF IT IS THAT GETS PASSED ON FOR

**** IMPORTANT INFORMATION ****

IT IS IMPORTANT FOR ALL INVOLVED WORKING IN THE THRIFT STORE TO COMPLY WITH THIS INFORMATION AS:

You could get a citation from the people who come around to make sure we are complying?

You could face a huge liability situation if you sold any of the restricted items and end up in court and your Underwriters are not going to cover you



Information resources and Contact Information - Consumer Product Safety Program

NOTICE: FOR FURTHER INFORMATION VISIT THE RESOURCES BELOW OR CONTACT A HEALTH CANADA CONSUMER PRODUCT SAFETY OFFICE VIA EMAIL (CPS-SPC@HC-SC.GC.CA) OR TELEPHONE AT 1-866-662-0666 (TOLL-FREE WITHIN CANADA AND THE UNITED STATES).

[CANADA CONSUMER PRODUCT SAFETY ACT
WWW.LAWS-LOIS.JUSTICE.GC.CA/ENG/ACTS/C-1.68/INDEX.HTML](http://WWW.LAWS-LOIS.JUSTICE.GC.CA/ENG/ACTS/C-1.68/INDEX.HTML)

[FOOD AND DRUGS ACT
WWW.LAWS-LOIS.JUSTICE.GC.CA/ENG/ACTS/F-27/INDEX.HTML](http://WWW.LAWS-LOIS.JUSTICE.GC.CA/ENG/ACTS/F-27/INDEX.HTML)

[COSMETIC REGULATIONS
WWW.LAWS-LOIS.JUSTICE.GC.CA/ENG/REGULATIONS/C.R.C.,_C._869/INDEX.HTML](http://WWW.LAWS-LOIS.JUSTICE.GC.CA/ENG/REGULATIONS/C.R.C.,_C._869/INDEX.HTML)

[CANADA CONSUMER PRODUCT SAFETY ACT QUICK REFERENCE GUIDE
WWW.HC-SC.GC.CA/CPS-SPC/PUBS/INDUST/CCPSA_REF-LCSPC/INDEX-ENG.PHP](http://WWW.HC-SC.GC.CA/CPS-SPC/PUBS/INDUST/CCPSA_REF-LCSPC/INDEX-ENG.PHP)

[TO SUBSCRIBE FOR EMAIL UPDATES ABOUT THE CANADA CONSUMER
PRODUCT SAFETY ACT
WWW.HC-SC.GC.CA/CPS-SPC/LEGISLATION/ACTS-LOIS/CCPSA-LCSPC/_SUBSCRIBE-ABONNEMENT/INDEX-ENG.PHP](http://WWW.HC-SC.GC.CA/CPS-SPC/LEGISLATION/ACTS-LOIS/CCPSA-LCSPC/_SUBSCRIBE-ABONNEMENT/INDEX-ENG.PHP)

[GUIDANCE ON MANDATORY INCIDENT REPORTING UNDER THE
CANADA CONSUMER PRODUCT SAFETY ACT - SECTION 14 DUTIES IN
THE EVENT OF AN INCIDENT
WWW.HC-SC.GC.CA/CPS-SPC/PUBS/INDUST/2011CCPSA_INCIDENT-LCSPC/INDEX-ENG.PHP](http://WWW.HC-SC.GC.CA/CPS-SPC/PUBS/INDUST/2011CCPSA_INCIDENT-LCSPC/INDEX-ENG.PHP)